

4/3, 4/2 and 3/2 directional valve with wet-pin AC or DC solenoid

RE 23178/12.05
Replaces: 04.05

1/16

Type WE 6 ...E

Size 6
Component series 6X
Maximum operating pressure 350 bar [5100 psi]
Maximum flow: 80 l/min [21 gpm] – DC
60 l/min [15.8 gpm] – AC

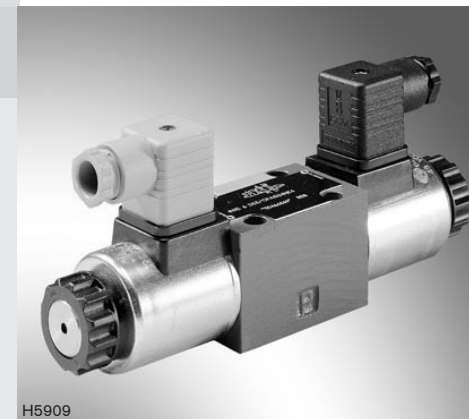

Table of contents

Contents	Page
Features	1
Order code	2
Standard types	3
Mating connectors	3
Spool symbols	4
Function, cross-section	5
Technical data	6, 7
Characteristic curves	8
Power limits	8 to 10
Dimensions	11 to 15

Features

- Direct operated directional spool valve, solenoid actuated, in heavy-duty configuration
- Port pattern as per DIN 24340 form A (without locating bore)
- Port pattern as per ISO 4401-03-02-0-94, NFPA T3.5.1 MR1 and ANSI B93-7 D03 (with locating bore/anti-rotation pin)
- For subplates, see data sheet RE 45052 (order separately)
- Wet-pin AC or DC solenoids with removeable coil
- Solenoid coil can be rotated through 90°
- Pressure-tight chamber need not be opened for coil replacement
- Electrical connection direct on coil or central via conduit box
- Manual override, optional
- Soft shift version, see RE 23183
- Inductive position indicator, contact-free, see RE 24830
- Other electrical connection see RE 08010

Information on available spare parts:
www.boschrexroth.com/spc

Order code

	WE	6		6X	/	E			/				*
3 main ports = 3													
4 main ports = 4													
NG 6, ISO4401-3, NFPA/ANSI D03 Interface = 6													
Spool symbols, e.g. C, E, EA, EB, etc; for possible versions, see page 4													
Component series 60 to 69 (60 to 69: unchanged installation and connection dimensions) = 6X													
Spring return = No code													
Without spring return = O													
Without spring return with detent = OF													
Heavy-duty solenoid wet-pin with removeable coil = E													
24 V DC = G24													
230 V AC 50/60 Hz = W230													
120 V oder 110 V AC 50 or 60 Hz = W110													
205 V DC = G205 ¹⁾													
Built-in rectifier / DC coils for 50/60 Hz AC voltage (only available with central connection, a D connector type conduit box, see page 3) = W110R													
For further ordering codes for other voltages and frequencies, see page 7													
With concealed manual override (standard) = N9													
With manual override = N													
Without manual override = No code													

- 1) If a DC solenoid is to be connected to AC voltage, then a rectifier must be used, suitable AC voltages are defined in the table below. When using individual coil connections, a mating connector with integrated rectifier may be used. (order separately)
- 2) Requires anti-Rotation pin as per ISO 8752-3x8-St, material number **R900005694**. (order separately for .../60 option)
- 3) Also available with M12 connector (option ...G24... only) For order code and mating connectors, see RE 08010.
- 4) DIN mating connector, order separately, see page 3.
- 5) Mating connector, order separately, material number **R900005538**

Note!

AC electricity supply system (permissible voltage tolerance ± 10%)	Nominal voltage of the DC solenoid when operated with rectified AC voltage	Order code
110 V - 50/60 Hz	96 V	G96
230 V - 50/60 Hz	205 V	G205

Further details in clear text

No code = Without locating bore
 /60²⁾ = With locating bore
 /62 = With locating bore and anti-rotation pin ISO 8752-3x8-St

Seal material
 No code = NBR seals
 V = FKM seals (other seals on enquiry)
⚠ Caution!
 Observe compatibility of seals with the hydraulic fluid used!

Clamping length
 No code = 42 mm (standard)
 Z = 22 mm

No code = Without throttle insert
 With throttle insert (see table)

Port	Throttle orifice Ø in mm		
	0,8	1,0	1,2
P	= B08	= B10	= B12
A	= H08	= H10	= H12
B	= R08	= R10	= R12
A and B	= N08	= N10	= N12
T	= X08	= X10	= X12

For use when the flow is higher than performance limit of the valve. (see remark page 5)

Electrical connection³⁾

Individual connection

K4⁴⁾ = Without mating connector with connector as per DIN EN 175301-803

Central connection

DL = Strain relief on box, with lights (LED)

DKL⁵⁾ = Central connector on box, with lights (LED) (without mating connector)

For electrical connection options see RE 08010

For standard types, see page 3!

Standard types

Type	Material number
4WE 6 J6X/EG12N9K4	R900567496
3WE 6 A6X/EG24N9K4	R900561180
3WE 6 B6X/EG24N9K4	R900561270
4WE 6 C6X/EG24N9K4	R900561272
4WE 6 C6X/OFEG24N9K4	R900564107
4WE 6 D6X/EG24N9K4	R900561274
4WE 6 D6X/OFEG24N9K4	R900567512
4WE 6 E6X/EG24N9K4	R900561278
4WE 6 EA6X/EG24N9K4	R900561280
4WE 6 EB6X/EG24N9K4	R900561281
4WE 6 G6X/EG24N9K4	R900561282
4WE 6 H6X/EG24N9K4	R900561286
4WE 6 HA6X/EG24N9K4	R900549534
4WE 6 J6X/EG24N9K4	R900561288
4WE 6 M6X/EG24N9K4	R900577475
4WE 6 Q6X/EG24N9K4	R900561292
4WE 6 R6X/EG24N9K4	R900571012
4WE 6 T6X/EG24N9K4	R900934414
4WE 6 U6X/EG24N9K4	R900572785
4WE 6 W6X/EG24N9K4	R900568233
4WE 6 Y6X/EG24N9K4	R900561276

Type	Material number
4WE 6 D6X/EW110N9K4	R900551704
4WE 6 D6X/OFEW110N9K4	R900552321
4WE 6 E6X/EW110N9K4	R900558641
4WE 6 J6X/EW110N9K4	R900551703
3WE 6 A6X/EW230N9K4	R900915672
4WE 6 C6X/EW230N9K4	R900913132
4WE 6 D6X/EW230N9K4	R900909559
4WE 6 D6X/OFEW230N9K4	R900915095
4WE 6 E6X/EW230N9K4	R900912492
4WE 6 H6X/EW230N9K4	R900912494
4WE 6 J6X/EW230N9K4	R900911762
4WE 6 Y6X/EW230N9K4	R900909415

For additional standard types and components please contact Product Support.

Mating connectors (DIN EN 175301-803)

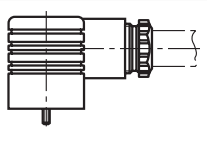
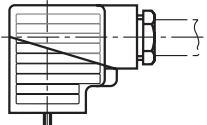
For details and additional mating connectors, see RE 08006							
Cable gland	Valve side	Color	Material Numbers				
			Without circuitry	With LED lamp 12 ... 240 V	With LED lamp and rectifier 12 ... 240 V	With rectifier 12 ... 240 V	With LED lamp and Zener diode suppressor circuit 24 V
M16 x 1,5	a	grey	R901017010	–	–	–	–
	b	black	R901017011	–	–	–	–
	a/b	black	–	R901017022	R901017029	R901017025	R901017026
1/2" NPT (Pg16)	a	red/brown	R900004823	–	–	–	–
	b	black	R900011039	–	–	–	–
	a/b	black	–	R900057453	R900057455	R900842566	–

Spool symbols

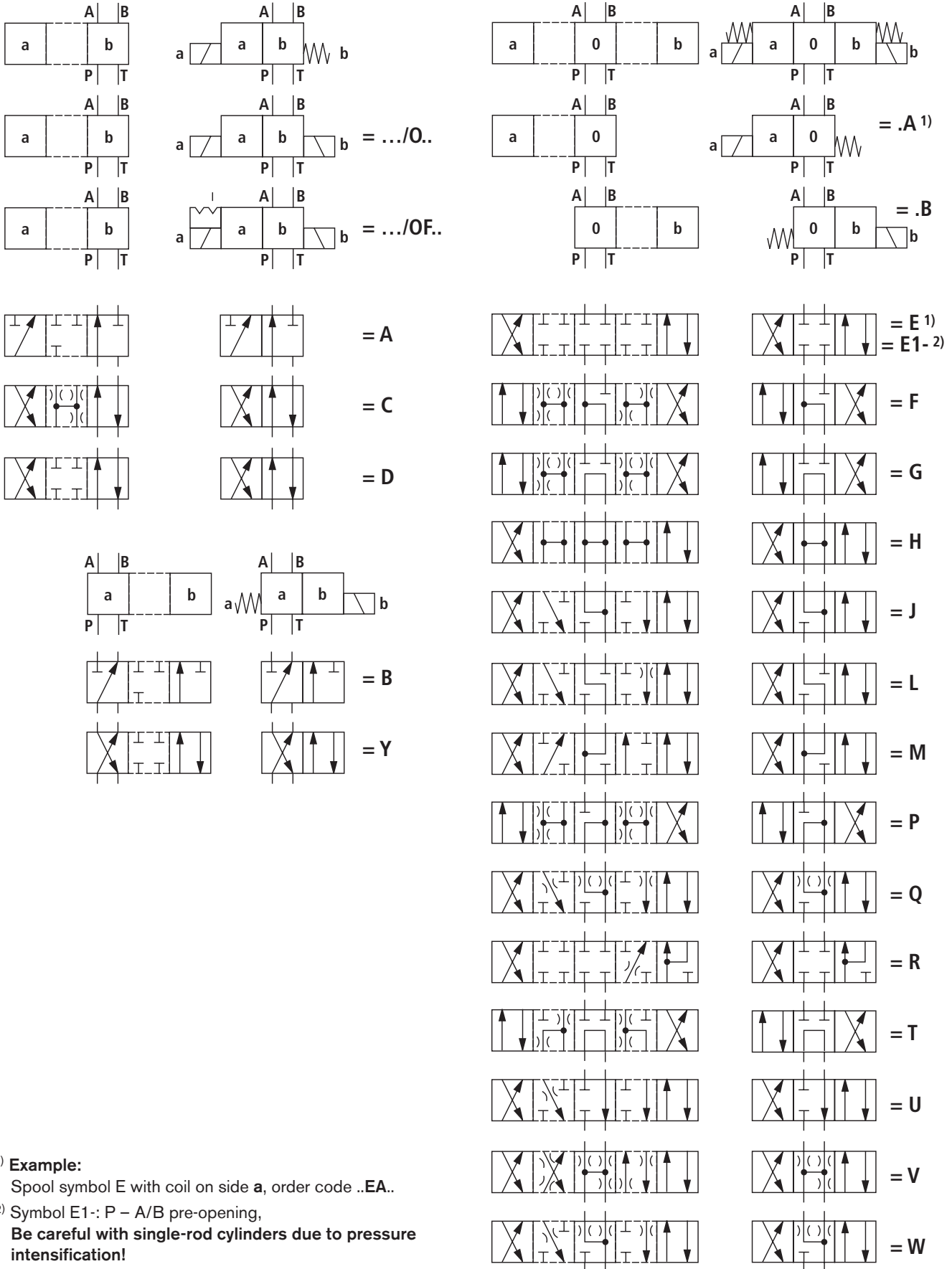

1) Example:

Spool symbol E with coil on side a, order code ..EA..

2) Symbol E1-: P - A/B pre-opening,

Be careful with single-rod cylinders due to pressure intensification!

Function, cross-section

Type WE control valves are solenoid operated directional spool valves. They control the start, stop and direction of a flow.

These directional valves basically consist of a housing (1), one or two solenoids (2), a control spool (3) as well as one or two return springs (4).

In the inactive condition, the control spool (3) is held in the central or initial position by return springs (4) (except for detent spools). Control spool (3) is actuated by wet-pin solenoids (2).

The force of solenoid (2) acts via plunger (5) on control spool (3) and shifts it from its initial position to the required end position. This enables the required direction of flow, P to A and B to T or P to B and A to T.

After solenoid (2) is de-energized, control spool (3) is again pushed to its initial position by return spring (4).

Manual override (6) allows control spool (3) to be moved without energizing the solenoid.

Type .WE 6.. 6X/O... (possible only with symbols A, C and D)

This version refers to two position directional spool valves consisting of two solenoids without detent. When de-energized, there is no predefined spool position.

Type .WE 6.. 6X/OF... (detent spool, possible only with symbols A, C and D)

This version refers to two position directional spool valves consisting of two solenoids and a detent. Detent holds the spool at its most recent position, and continuous solenoid excitation is not required.

 **Note!**

Pressure peaks in a tank line connected to two or more detent type valves, can cause unintended spool movement! In this situation, it is recommended that separate return lines be used or a check valve must be installed in the tank line.

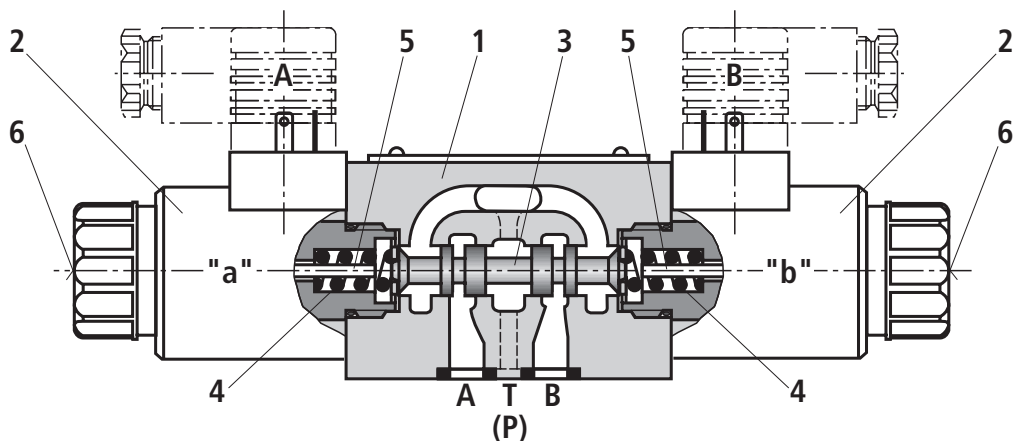

Type 4WE 6 E6X/...E...

Throttle insert (type .WE 6..6X/.../B..)

The use of throttle inserts is required, when, due to prevailing operating conditions, flows can occur during valve switching, that exceed the power limits of the valve. These orifices are inserted into the valve body's P-port.

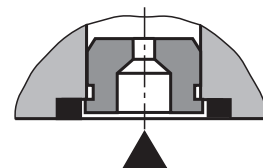

Technical data (for applications exceeding these parameters, please consult product support!)

General			
Weight	- Valve with one solenoid	kg [lbs]	1.45 [3.2]
	- Valve with two solenoids	kg [lbs]	1.95 [4.3]
Mounting orientation			Unrestricted
Ambient temperature range		°C [°F]	-30 to +50 [-22 to +122] (NBR seals) -20 to +50 [-4 to +122] (FKM seals)
Hydraulic			
Maximum operating pressure	- Ports A, B, P	bar [psi]	350 [5100]
	- Port T	bar [psi]	210 [3050] (DC); 160 [2320] (AC) For symbols A and B, port T must be used as the drain port, if the operating pressure is higher than the tank pressure.
Maximum flow		l/min [gpm]	80 [21] (DC); 60 [15.8] (AC)
Flow cross-section (centered spool)	- Spool symbol Q	mm ²	approx. 6 % of nominal cross-section
	- Spool symbol W	mm ²	approx. 3 % of nominal cross-section
Hydraulic fluid			Mineral oil (HL, HLP) to DIN 51524 ¹⁾ ; fast bio-degradable hydraulic fluids to VDMA 24568 (see also RE 90221); HETG (rape-seed oil) ¹⁾ ; HEPG (polyglycols) ²⁾ ; HEES (synthetic esters) ²⁾ ; other hydraulic fluids upon request
Hydraulic fluid temperature range		°C [°F]	-30 to +80 [-22 to +176] (NBR seals) -15 to +80 [-4 to +176] (FKM seals)
Viscosity range		mm ² /s [SUS]	2,8 to 500 [35 to 2320]
Max. permissible degree of contamination of the hydraulic fluid - cleanliness class to ISO 4406 (c)			Class 20/18/15 ³⁾

¹⁾ Suitable for NBR **and** FKM seals

²⁾ Suitable **only** for FKM seals

³⁾ The cleanliness classes specified for components must be adhered to in hydraulic systems. Effective filtration prevents malfunction and, at the same time, increases the service life of components.

For the selection of filters, see data sheets RE 50070, RE 50076, RE 50081, RE 50086 and RE 50088.

Technical data (for applications exceeding these parameters, please consult product support!)

Electrical			
Voltage type		DC	AC 50/60 Hz
Available voltages ⁴⁾ (for AC solenoid order codes, see below)	V	12, 24, 96, 205	110, 230
Voltage tolerance (nominal voltage)	%	± 10	± 10
Power consumption	W	30	–
Holding current	VA	–	50
Inrush current	VA	–	220
Duty cycle		100 %	100 %
Switching time per ISO 6403	ON	ms	25 to 45
	OFF	ms	10 to 25
Maximum switching frequency	1/h	15000	7200
Maximum coil temperature ⁵⁾	°C [°F]	150 [302]	180 [356]
Type of protection to DIN EN 60529 ⁶⁾		IP 65	IP 65

⁴⁾ Other voltages upon request

⁵⁾ Due to the solenoid coil surface temperatures, please observe European safety standards EN563 and EN982!

⁶⁾ With mating connector mounted and secured

Note!

AC solenoids can be used only for 2 or 3 voltage/frequency relationships; e.g. solenoid type **W110** for:

110 V, 50 Hz; 110 V, 60 Hz; 120 V, 60 Hz

Order code	Power supply
W110	110 V, 50 Hz
	110 V, 60 Hz
	120 V, 60 Hz
W230	230 V, 50 Hz
	230 V, 60 Hz

When connecting wires, properly connect the PE ground conductor (PE \perp).

Characteristic curves (measured with HLP46, $\vartheta_{oil} (v=190 \text{ SUS}) = 40 \text{ }^\circ\text{C} \pm 5 \text{ }^\circ\text{C} [104 \text{ }^\circ\text{F} \pm 9 \text{ }^\circ\text{F}]$)

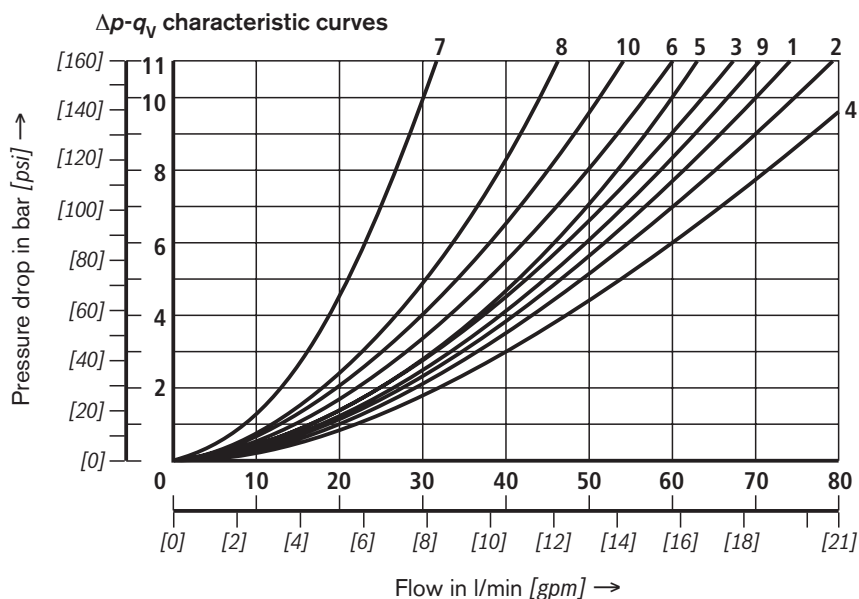

Spool symbol	Direction of flow			
	P - A	P - B	A - T	B - T
A; B	3	3	-	-
C	1	1	3	1
D; Y	5	5	3	3
E	3	3	1	1
F	1	3	1	1
T	10	10	9	9
H	2	4	2	2
J; Q	1	1	2	1
L	3	3	4	9
M	2	4	3	3
P	3	1	1	1
R	5	5	4	-
V	1	2	1	1
W	1	1	2	2
U	3	3	9	4
G	6	6	9	9

- 7 Spool symbol R in spool position B - A
- 8 Spool symbol G and T in central position P - T
- 9 Spool symbol H in central position P - T

Power limits (measured with HLP46, $\vartheta_{oil} (v=190 \text{ SUS}) = 40 \text{ }^\circ\text{C} \pm 5 \text{ }^\circ\text{C} [104 \text{ }^\circ\text{F} \pm 9 \text{ }^\circ\text{F}]$)

⚠ Caution!

The specified switching performance limits are valid with two directions of flow (e.g. from P to A and simultaneous return flow from B to T).

Due to the flow forces acting within the valve, the permissible switching performance limit can be significantly lower with

only one direction of flow (e.g. from P to A, with port B being blocked)!

In such cases, please consult product support!

The switching performance limit was determined with the solenoid at operating temperature, at 10 % under-voltage and without tank pre-loading.

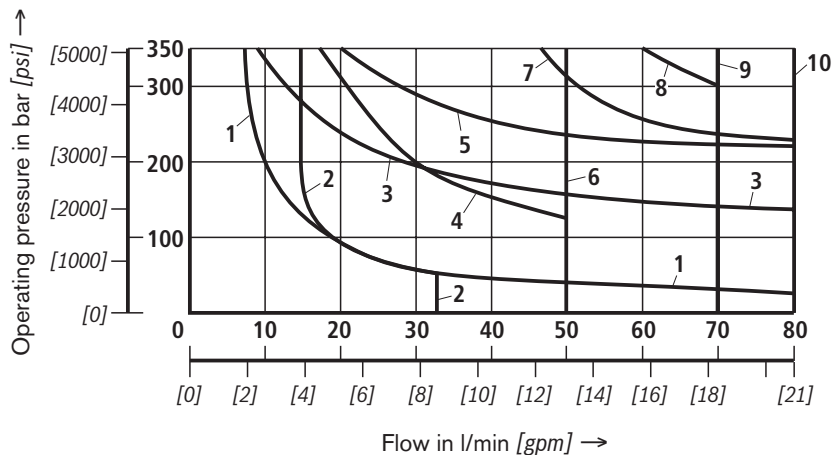

DC solenoid
Solenoid voltage
12; 24; 48; 96; 125; 205 V

(for other voltages, see page 10)

DC solenoid	
Char. curve	Spool symbol
1	A; B ¹⁾
2	V
3	A; B
4	F; P
5	J
6	G; H; T
7	A/O; A/OF; L; U
8	C; D; Y
9	M
10	E; E1- ²⁾ ; R ³⁾ ; C/O; C/OF D/O; D/OF; Q; W

¹⁾ With manual override

²⁾ P - A/B pre-opening

³⁾ Return flow from actuator to tank

Power limits (measured with HLP46, $\vartheta_{oil} (v = 190 \text{ SUS}) = 40 \text{ }^\circ\text{C} \pm 5 \text{ }^\circ\text{C} [104 \text{ }^\circ\text{F} \pm 9 \text{ }^\circ\text{F}]$)

– see page 8

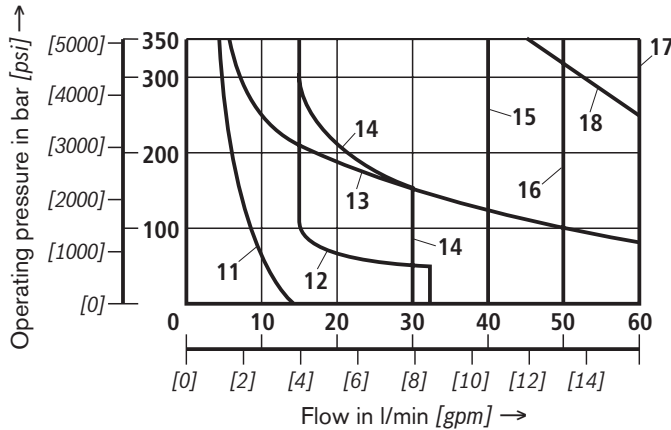

AC solenoid Solenoid voltage	
W110	110 V; 50 Hz 120 V; 60 Hz
W230	230 V; 50 Hz

(other voltages upon request)

AC solenoid – 50 Hz	
Char. curve	Spool symbol
11	A; B ¹⁾
12	V
13	A; B
14	F; P
15	G; T
16	H
17	A/O; A/OF; C/O; C/OF; D/O; D/OF; E; E1 ⁻²⁾ ; J; L; M; Q; R ³⁾ ; U; W
18	C; D; Y

¹⁾ With manual override

²⁾ P – A/B pre-opening

³⁾ Return flow from actuator to tank

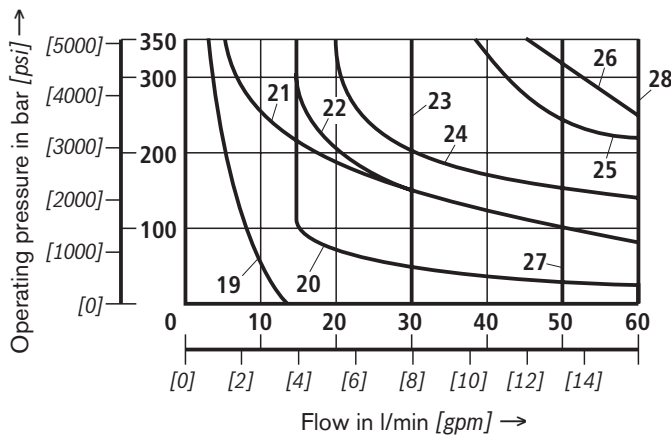

AC solenoid Solenoid voltage	
W110	110 V; 60 Hz
W230	230 V; 60 Hz

(other voltages upon request)

AC solenoid – 60 Hz	
Char. curve	Spool symbol
19	A; B ¹⁾
20	V
21	A; B
22	F; P
23	G; T
24	J; L; U
25	A/O; A/OF; Q; W
26	C; D; Y
27	H
28	C/O; C/OF; D/O; D/OF; E E1 ⁻²⁾ ; M; R ³⁾

¹⁾ With manual override

²⁾ P – A/B pre-opening

³⁾ Return flow from actuator to tank

Power limits (measured with HLP46, $\vartheta_{oil} (v = 190 \text{ SUS}) = 40 \text{ }^\circ\text{C} \pm 5 \text{ }^\circ\text{C} [104 \text{ }^\circ\text{F} \pm 9 \text{ }^\circ\text{F}]$)

– see page 8

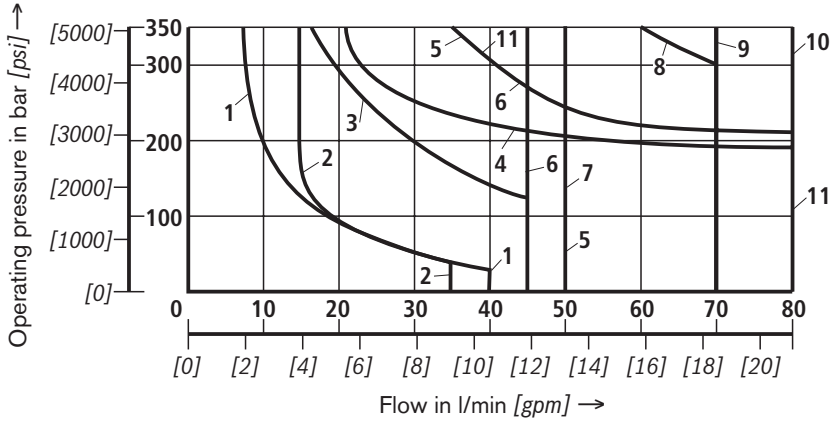

DC solenoid
Solenoid voltage
110; 180 V

DC solenoid	
Char. curve	Spool symbol
1	A; B
2	V
3	F; P
4	J; L; U
5	G
6	T
7	H
8	D; C
9	M
10	C/O; C/OF; D/O; D/OF; E; E1-; R; Q; W
11	A/O; A/OF

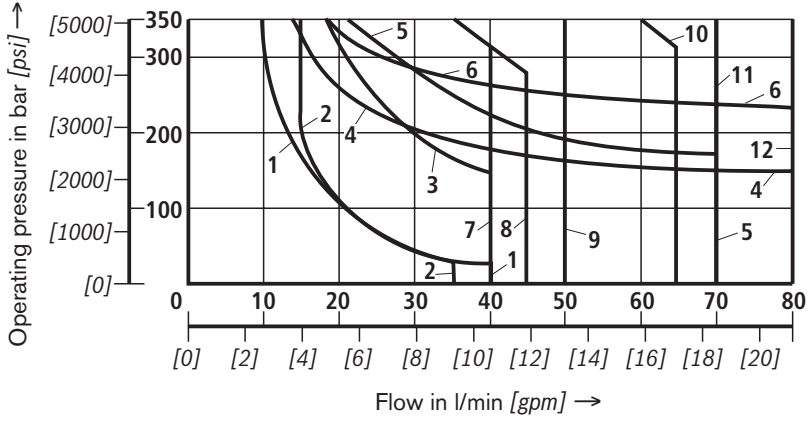

DC solenoid
Solenoid voltage
42; 80; 220 V

DC solenoid	
Char. curve	Spool symbol
1	A; B
2	V
3	F; P
4	J; L; U
5	A/O; A/OF
6	E
7	T
8	G
9	H
10	D; C
11	M
12	C/O; C/OF; D/O; D/OF; E1-; R; Q; W

Dimensions: Valve with DC solenoid – individual coil connection (nominal dimensions in mm [inch])

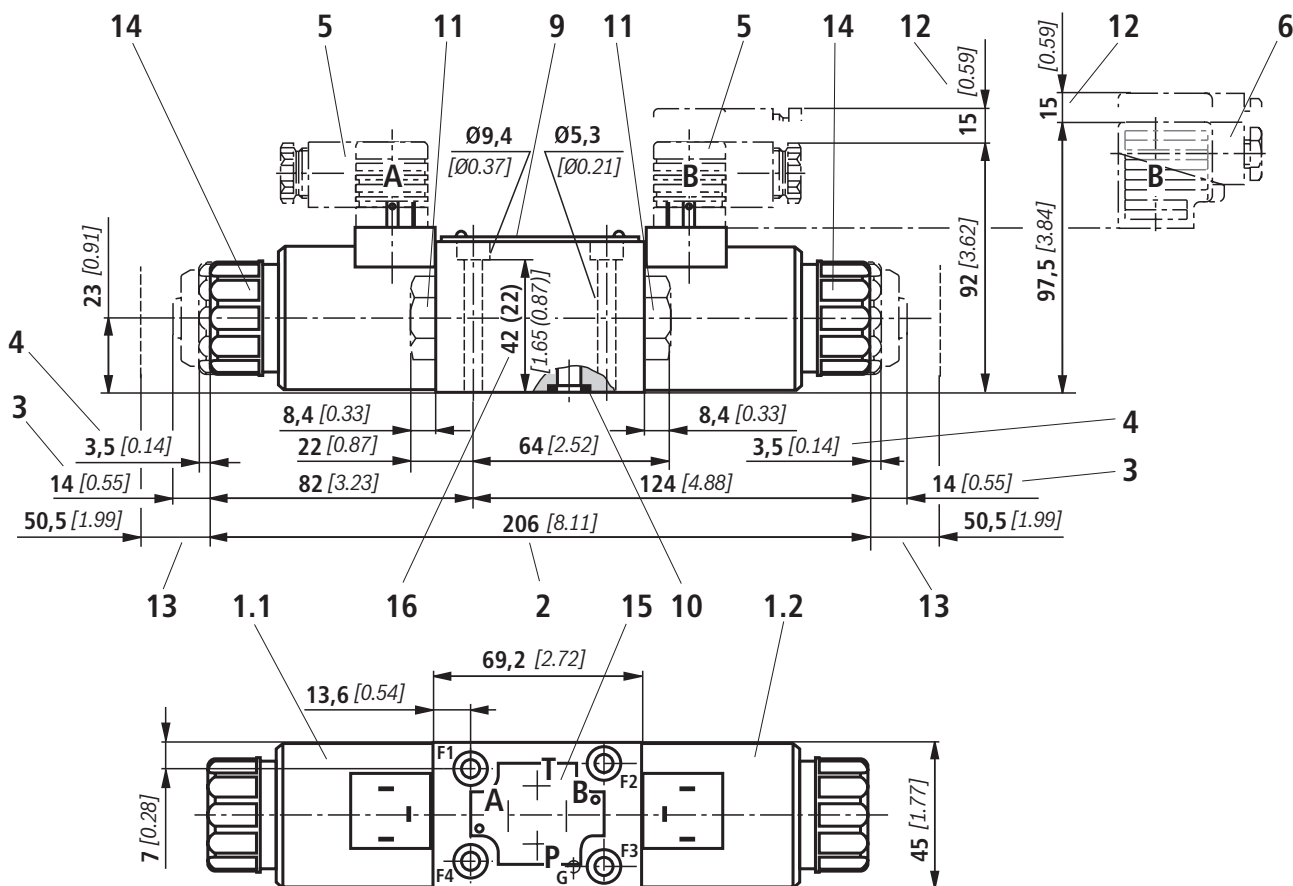

0.0004/4.0 in
0,01/100mm

Rzmax 4

Required surface quality of the valve mounting face

- | | |
|--|--|
| <ul style="list-style-type: none"> 1.1 Solenoid a (ANSI coil designation see RE 08010) 1.2 Solenoid b (ANSI coil designation see RE 08010) 2 Dimension for solenoid with concealed manual override N9 (standard) – the manual override can only be operated at tank pressures up to approx. 50 bar [725 psi]. Use tool R900024923 to prevent damage to override! 3 Dimension for solenoid with manual override N 4 Dimension for solenoid without manual override 5 DIN mating connector without circuitry (order separately, see page 3 and RE 08006) 6 DIN mating connector with circuitry order separately, see page 3 and RE 08006) 9 Nameplate 10 Identical seal rings for ports A, B, P, T 11 Screw plug for valves with one solenoid | <ul style="list-style-type: none"> 12 Space required to remove mating connector 13 Space required to remove coil 14 Hand nut, tightening torque $M_T = 4 \text{ Nm}$ [2.95 ft-lbs] 15 Port pattern as per DIN 24340 form A (without locating bore), or ISO 4401-03-02-0-94, NFFA T3.5.1 MR1 and ANSI B93-7 D03 interface (with locating bore for anti-rotation pin ISO 8752-3x8-St, material number R900005694, order separately for .../60 option) 16 Alternative clamping length (Z): 22 mm [0.87 inch] |
|--|--|

Subplates and valve mounting bolts see page 15.

Dimensions: Valve with DC solenoid – central coil connection (nominal dimensions in mm [inch])

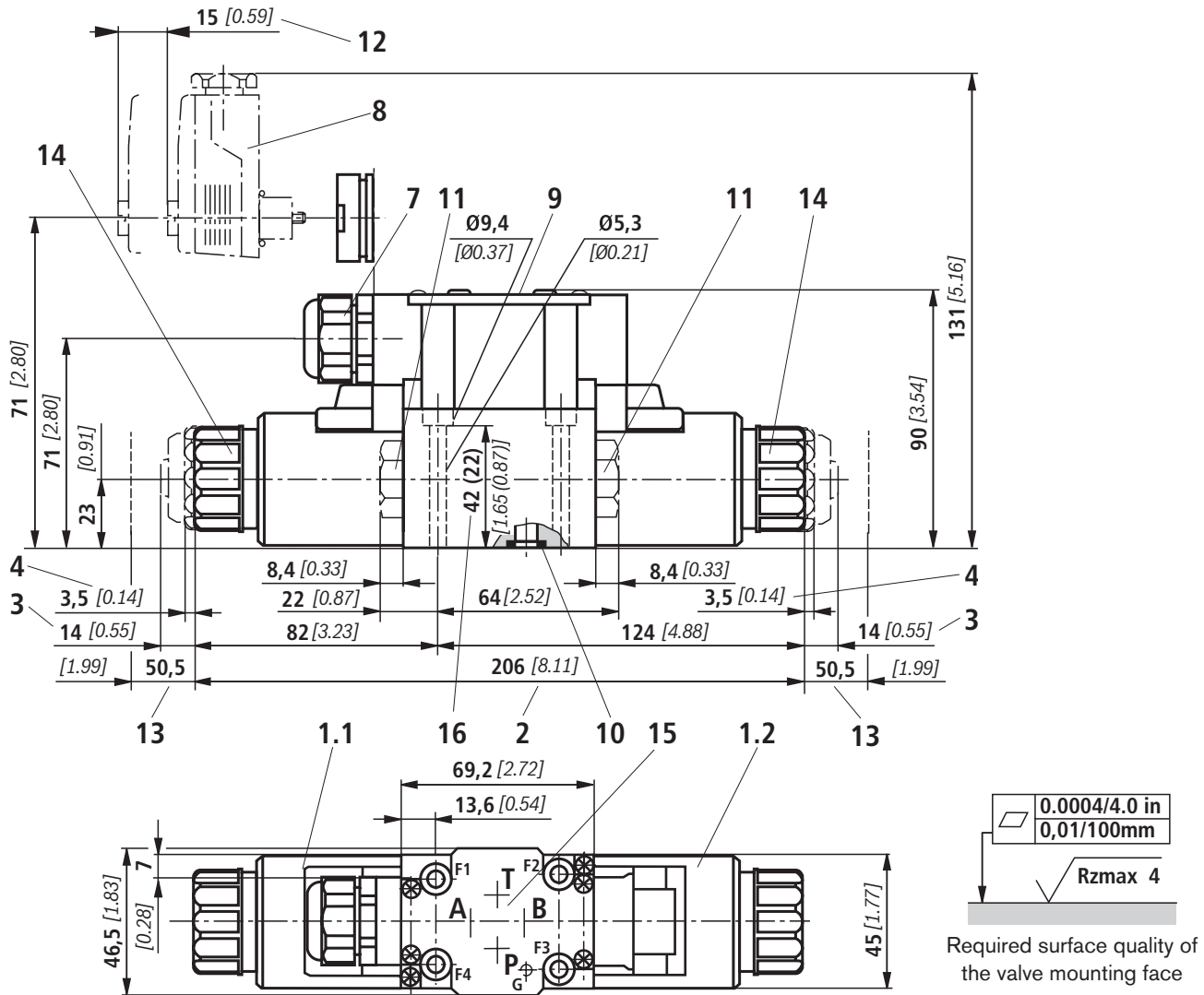

- 1.1 Solenoid **a** (ANSI coil designation see RE 08010)
- 1.2 Solenoid **b** (ANSI coil designation see RE 08010)
- 2 Dimension for solenoid **with concealed** manual override **N9** (standard) – the manual override can only be operated at tank pressures up to approx. 50 bar [725 psi]. Use tool R900024923 to prevent damage to override!
- 3 Dimension for solenoid **with** manual override **N**
- 4 Dimension for solenoid **without** manual override
- 7 Cable gland Pg 16 [1/2" NPT] **D** or **DL**
- 8 Angled mating connector (color: red, order separately, Material number **R900005538**)
- 9 Nameplate
- 10 Identical seal rings for ports A, B, P, T
- 11 Screw plug for valves with one solenoid
- 12 Space required to remove mating connector
- 13 Space required to remove coil
- 14 Hand nut, tightening torque $M_T = 4 \text{ Nm}$ [2.95 ft-lbs]

- 15 Port pattern as per DIN 24340 Form A (**without** locating bore), or ISO 4401-03-02-0-94, NFPA T3.5.1 MR1 and ANSI B93-7 D03 interface (**with** locating bore for anti-rotation pin ISO 8752-3x8-St, material number **R900005694**, order separately for .../60 option)
- 16 Alternative clamping length (Z): 22 mm [0.87 inch]

Conduit D box:

Terminal assignment for central connection

- 1 solenoid:

Solenoid always to screw terminals 1 and 2,
Ground to screw terminal \ominus PE

- 2 solenoids:

Solenoid on **a** side to screw terminals 1 and 2,
Solenoid on **b** side to screw terminals 3 and 4,
Ground to screw terminal \ominus PE

Subplates and valve mounting bolts see page 15.

Dimensions: Valve with AC solenoid – individual coil connection (nominal dimensions in mm [inch])

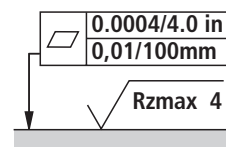
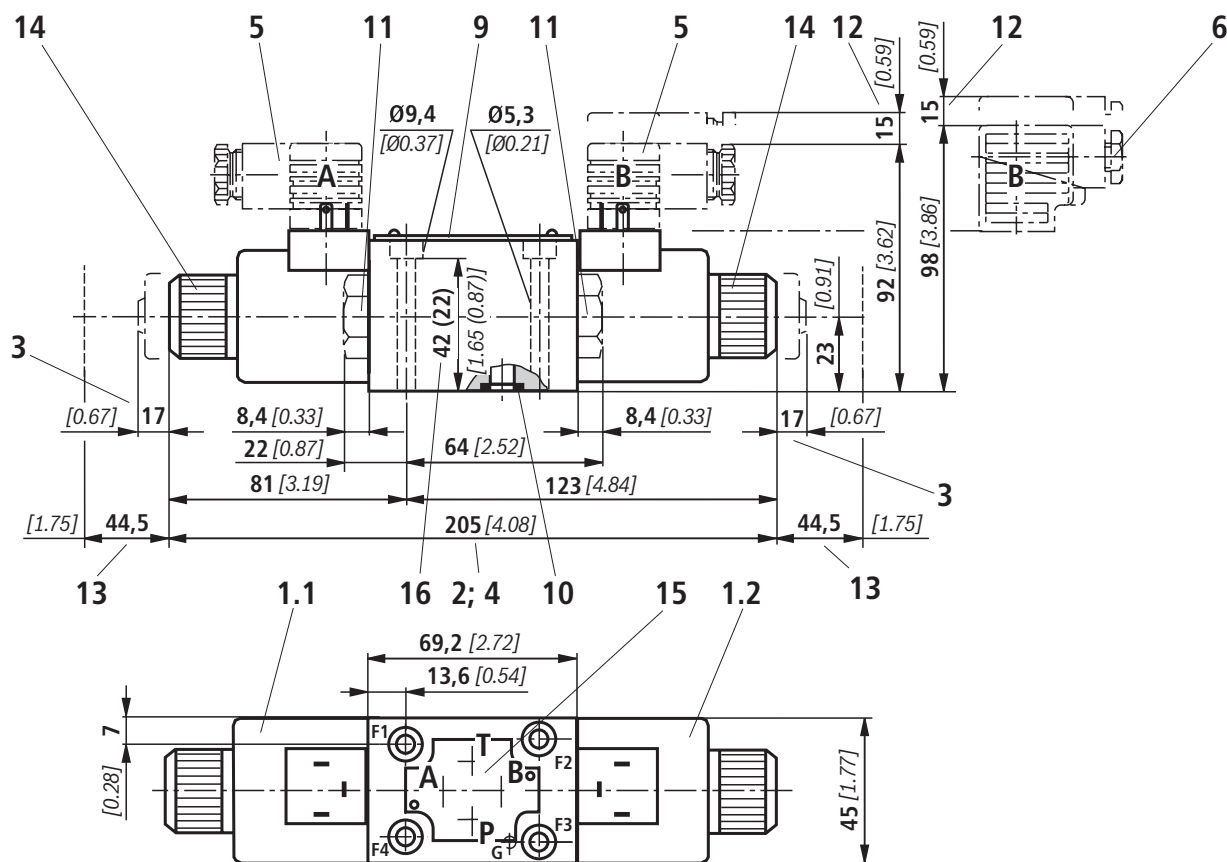

Required surface quality of the valve mounting face

- | | |
|--|--|
| <ul style="list-style-type: none"> 1.1 Solenoid a (ANSI coil designation see RE 08010) 1.2 Solenoid b (ANSI coil designation see RE 08010) 2 Dimension for solenoid with concealed manual override N9 (standard) – the manual override can only be operated at tank pressures up to approx. 50 bar [725 psi]. Use tool R900024923 to prevent damage to override! 3 Dimension for solenoid with manual override N 4 Dimension for solenoid without manual override 5 DIN mating connector without circuitry (order separately, see page 3 and RE 08006) 6 DIN mating connector with circuitry order separately, see page 3 and RE 08006) 9 Nameplate | <ul style="list-style-type: none"> 10 Identical seal rings for ports A, B, P, T 11 Screw plug for valves with one solenoid 12 Space required to remove mating connector 13 Space required to remove coil 14 Hand nut, tightening torque $M_T = 4 \text{ Nm}$ [2.95 ft-lbs] 15 Port pattern as per DIN 24340 form A (without locating bore), or ISO 4401-03-02-0-94, NFPA T3.5.1 MR1 and ANSI B93-7 D03 interface (with locating bore for anti-rotation pin ISO 8752-3x8-St, material number R900005694, order separately for .../60 option) 16 Alternative clamping length (Z): 22 mm [0.87 inch] |
|--|--|

Subplates and valve mounting bolts see page 15.

Dimensions: Valve with AC solenoid – central coil connection
(nominal dimensions in mm [inch])

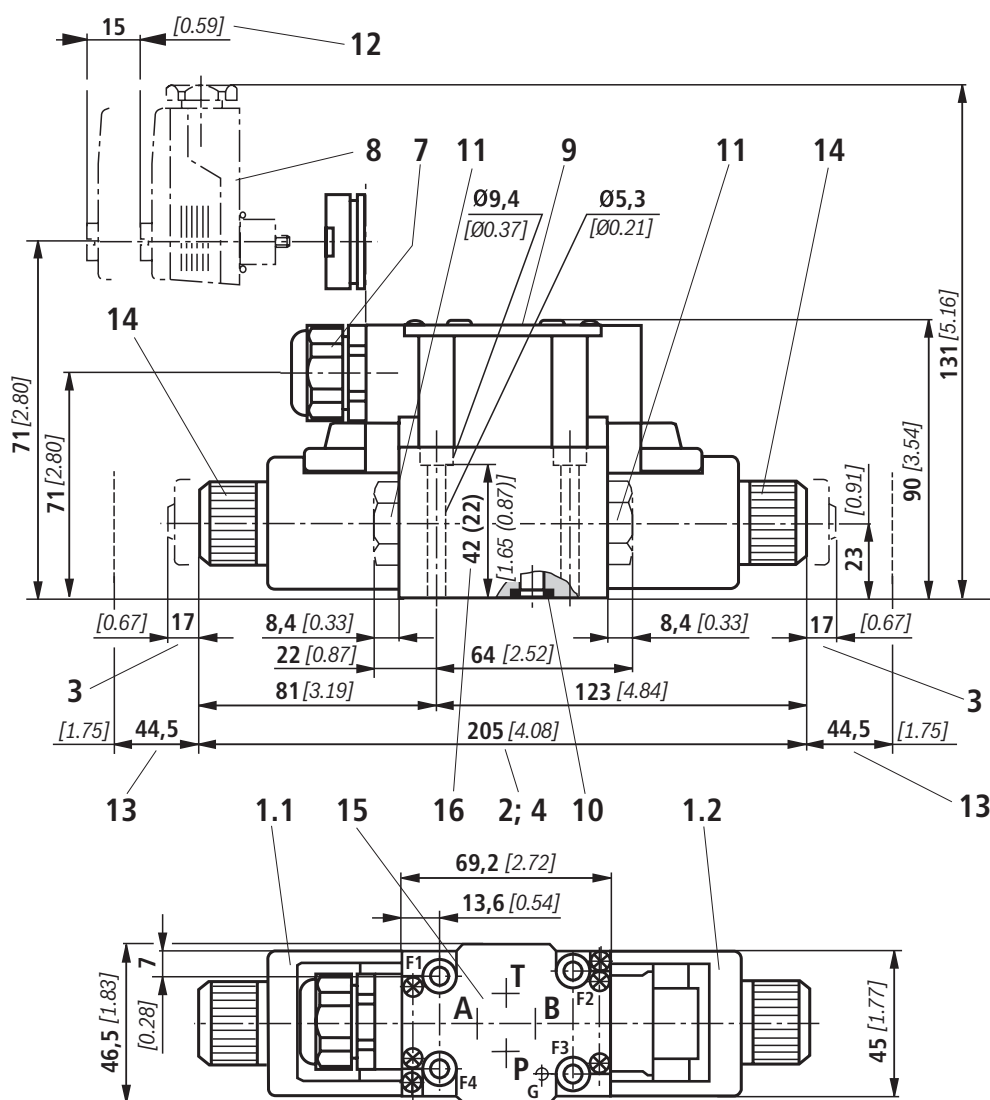

0.0004/4.0 in
0,01/100mm
Rzmax 4

Required surface quality of the valve mounting face

- 1.1 Solenoid **a** (ANSI coil designation see RE 08010)
- 1.2 Solenoid **b** (ANSI coil designation see RE 08010)
- 2 Dimension for solenoid **with concealed** manual override **N9** (standard) – the manual override can only be operated at tank pressures up to approx. 50 bar [725 psi]. Use tool R900024923 to prevent damage to override!
- 3 Dimension for solenoid **with** manual override **N**
- 4 Dimension for solenoid **without** manual override
- 7 Cable gland Pg 16 [1/2" NPT] **D** or **DL**
- 8 Angled mating connector (color: red, order separately, Material number **R900005538**)
- 9 Nameplate
- 10 Identical seal rings for ports A, B, P, T
- 11 Screw plug for valves with one solenoid
- 12 Space required to remove mating connector
- 13 Space required to remove coil
- 14 Hand nut, tightening torque $M_T = 4 \text{ Nm}$ [2.95 ft-lbs]
- 15 Port pattern as per DIN 24340 Form A (**without** locating bore), or ISO 4401-03-02-0-94, NFPA T3.5.1 MR1 and ANSI B93-7 D03 interface (**with** locating bore for anti-rotation pin ISO 8752-3x8-St, material number **R900005694**, order separately for .../60 option)
- 16 Alternative clamping length (Z): 22 mm [0.87 inch]

Conduit D box:

Terminal assignment for central connection

- 1 solenoid:

Solenoid always to screw terminals 1 and 2, Ground to screw terminal \oplus PE

- 2 solenoids:

Solenoid on **a** side to screw terminals 1 and 2, Solenoid on **b** side to screw terminals 3 and 4, Ground to screw terminal \oplus PE

Subplates and valve mounting bolts see page 15.

Dimensions

Subplates to data sheet RE 45052 (order separately)

- **without** locating bore
 - G 341/01 (G1/4)
 - G 342/01 (G3/8)
 - G 502/01 (G1/2)
- **with** locating bore
 - G 341/60 (G1/4)
 - G 342/60 (G3/8)
 - G 502/60 (G1/2)
 - G 341/12 (SAE-6)
 - G 342/12 (SAE-8)
 - G 502/12 (SAE-10)

Valve mounting bolts (order separately)

- Clamping length 42 mm:
 - 4 socket head cap screws (SHCS)**
 - ISO 4762 - M5 x 50 - 10.9-fIZn-240h-L or 10-24 UNC x 2"**
 - (friction coefficient $\mu_{\text{total}} = 0.09$ to 0.14);
 - tightening torque $M_T = 7 \text{ Nm}$ [5.2 ft-lbs] $\pm 10\%$,
 - material number metric **R913000064**
 - material number UNC **R978800693**
 - or
 - 4 socket head cap screws (SHCS)**
 - ISO 4762 - M5 x 50 - 10.9**
 - (friction coefficient $\mu_{\text{total}} = 0.12$ to 0.17);
 - tightening torque $M_T = 8.1 \text{ Nm}$ [6 ft-lbs] $\pm 10\%$,
- Clamping length 22 mm:
 - 4 socket head cap screws (SHCS)**
 - ISO 4762 - M5 x 30 - 10.9-fIZn-240h-L or 10-24 UNC x 1 1/4"**
 - (friction coefficient $\mu_{\text{total}} = 0.09$ to 0.14);
 - tightening torque $M_T = 7 \text{ Nm}$ [5.2 ft-lbs] $\pm 10\%$,
 - material number metric **R913000316**
 - material number UNC **R978802879**
 - or
 - 4 socket head cap screws (SHCS)**
 - ISO 4762 - M5 x 30 - 10.9**
 - (friction coefficient $\mu_{\text{total}} = 0.12$ to 0.17);
 - tightening torque $M_T = 8.1 \text{ Nm}$ [6 ft-lbs] $\pm 10\%$

Notes
